

Airstream®



NSF 49 UL 61010
Model AC2-4S-NS

Class II Type A2 Biological Safety Cabinets
The World's Leading Compact, Energy-Efficient,
and Quiet Biosafety Cabinet



ESCO
SCIENTIFIC



RS 232 Serial Interface Port and Voltage Free Relay Contact

- Send operational information to Building Management System (BMS)
- Zero Volt Relay Contact to turn ON/OFF exhaust blower and signal the building alarm

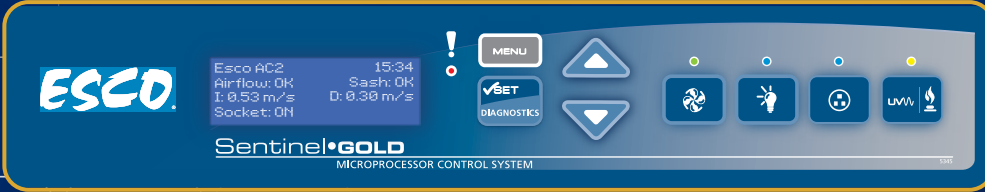

Sentinel™ Gold Microprocessor Controller

- Displays all safety information on one screen
- Centered and angled down for easy reach & viewing
- Selectable Quickstart mode for fast operation



Single-Piece Wall

- Easy to reach service fixture and outlets
- Large radius for easy cleaning



Single-Piece Work Tray

- Recessed to contain spillage
- Sloped perimeter that's easy to wipe



Raised Arm Rest

- Helps prevent grille blocking
- Comfortable working posture

Available in 0.9, 1.2, 1.5 and 1.8 meter width (3', 4' 5" and 6')



NSF 49



UL 61010



Airflow Sensor

- Monitors real-time airflow for safety
- Alert the user if airflow is insufficient

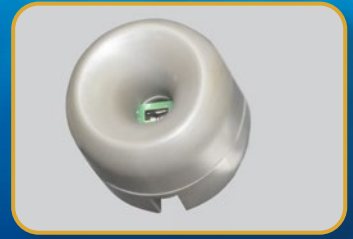

Energy-Efficient DC ECM Motor

- The leading energy efficient Class II Type A2 Biosafety Cabinet in the world with 70% Energy savings compared to AC motor
- Stable airflow, despite building voltage fluctuations & filter loading
- Stand by mode to further reduce power consumption by 60%

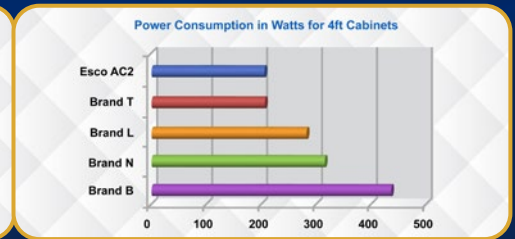
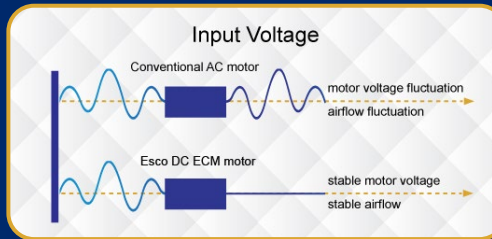

ULPA Filter

- 10x Filtration efficiency of HEPA filter
- Creates ISO Class 3 work zone instead of industry-standard ISO Class 5

Dynamic Chamber™

- Blower plenum and side walls are surrounded by negative pressure
- Prevent contaminants from escaping outside

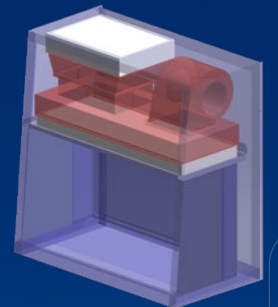

Positive pressure
Negative pressure

Angled Sash

- 5° angled front to optimize user comfort, reduce glare and maximize reach into the work area

ISOCIDE™ Powder Coat

- Silver-ion impregnated powder coat
- Inhibit microbial growth to improve safety

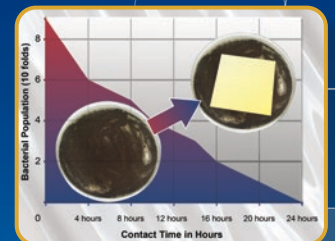

Removable Paper Catch

- Easy to clean
- Optional pre-filter can be fitted



Certification

	Biosafety Cabinets	Air Quality	Filtration	Electrical Safety
Standards Compliance	NSF / ANSI 49 NSF*	ISO 14644.1, Class 3, Worldwide JIS B9920, Class 3, Japan BS5295, Class 3, UK US Fed Std 209E, Class 1 USA	EN-1822 (H14), Europe IEST-RP-CC001.3, USA IEST-RP-CC007, USA IEST-RP-CC034.1, USA	UL-61010A-1, USA CSA22.2, No.1010-192, Canada EN-61010-1, Europe IEC61010-1, Worldwide

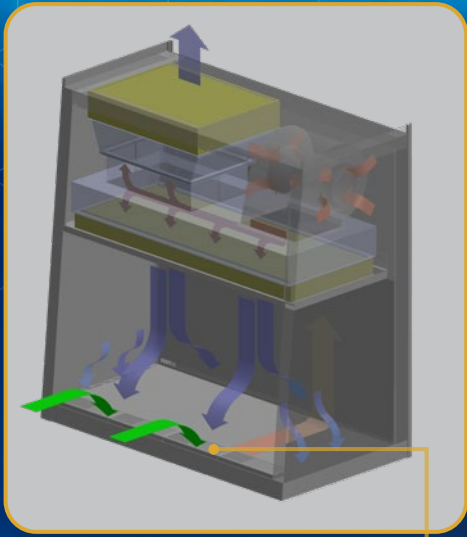

- ULPA-filtered air
- Unfiltered / potentially contaminated air
- Room air / Inflow air

Cabinet Filtration System

- Ambient air is pulled through front grille to create inflow, without going into the work surface. Inflow is joined by half of the downflow, to create front air curtain that is fine-tuned to create a large performance envelope. The combined air stream travels through the back air column towards the blower.
- Approximately 1/3 of the air in the common plenum is exhausted through the ULPA filter to the room. The remaining 2/3 of the air is passed through the downflow ULPA filter and into the work area as a vertical laminar flow air to create ISO Class 3 work surface and prevents cross contamination.
- Near the work surface, the downflow splits. About Half goes to the front grille, and half goes to the rear grille. A small portion enters the side capture zones to prevent dead air corners (small blue arrows)
- The design was optimized to give large performance envelope, that provides operator and product protection at wide Inflow and Downflow variation from the Nominal point.

Dynamic air barrier, where inflow and forward-directed downflow air converge

Performance Envelope Test of AC2-NS

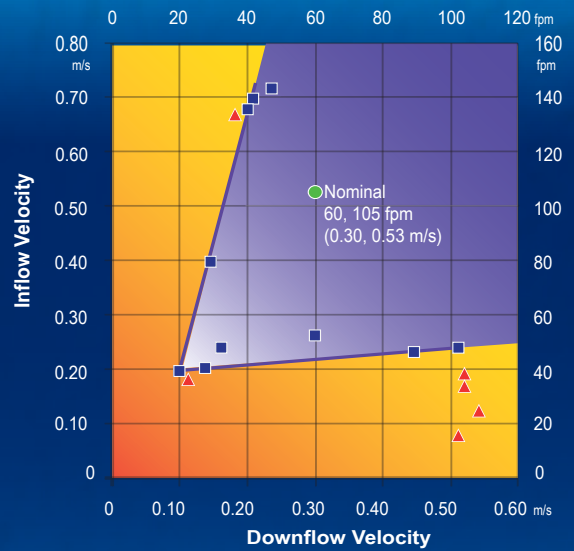

- Nominal Airflow
- Personnel / Product Protection
- Area of Personnel and Product Protection
- ▲ NO Personnel / Product Protection

AC2-NS Engineering Drawing

4

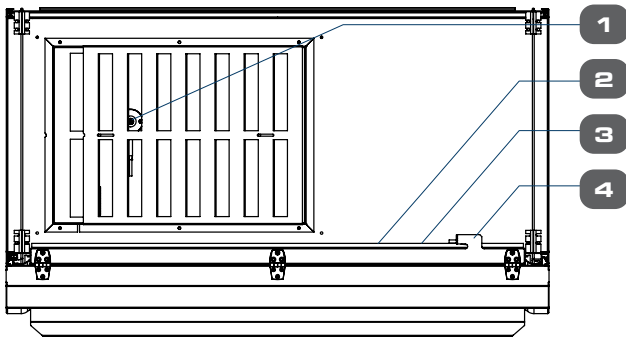

1. Airflow Sensor
2. Voltage Free Relay Contact
3. RS232 Port
4. Power Inlet
5. Esco Sentinel™ Gold Microprocessor Control System
6. Tempered Glass Sliding Sash Window
7. Ergonomic Sash Handle
8. Single Piece Stainless Steel Work Tray
9. Electrical Panel
10. Curved Front Panel
11. Control Panel
12. Energy-efficient T5 Fluorescent Lamps
13. IV Bar Retrofit Kit Provision
14. Steris VHP / Bioquell HPV Provision (Optional)
15. Provision for Service Fixtures (2 on each side)
16. Duplex GFCI Electrical Outlets (1 on each side)
17. Stainless Steel Arm Rest
18. Drain Hole
19. Exhaust ULPA / H14 Filter
20. DC ECM Blower (Energy Efficient & Self-Compensating)
21. Downflow ULPA / H14 Filter
22. Paper Catch

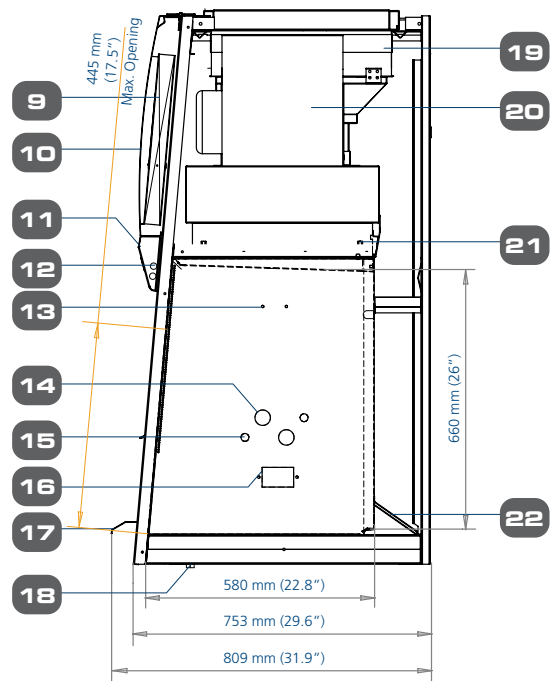
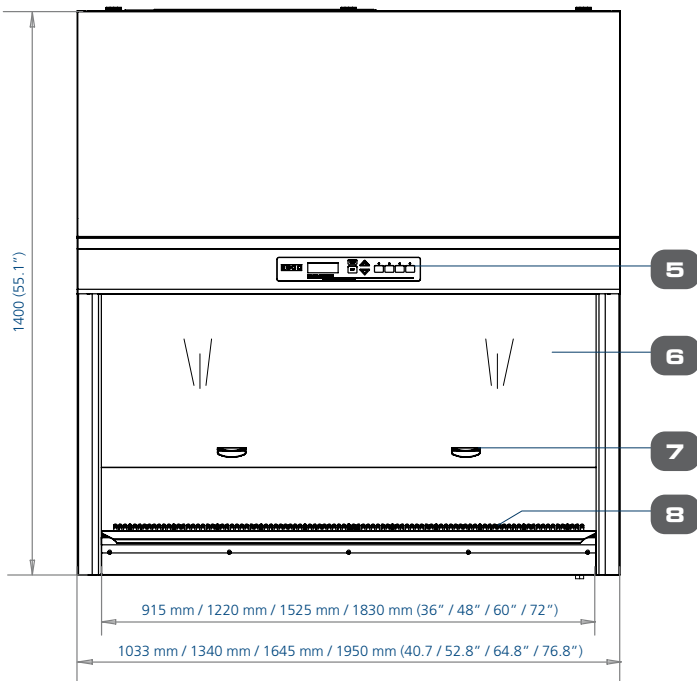

TECHNICAL SPECIFICATIONS

Model	220-240 VAC, 50/60Hz	AC2-3S8-NS 2010946	AC2-4S8-NS 2010747	AC2-5S8-NS 2010978	AC2-6S8-NS 2010963
	110-130 VAC, 50/60 Hz	AC2-3S9-NS 2010945	AC2-4S9-NS 2010752	AC2-5S9-NS 2010977	AC2-6S9-NS 2010925
External Dimensions (W x D x H)		1035 x 753 x 1400 mm (40.7" x 29.6" x 55.1")	1340 x 753 x 1400 mm (52.8" x 29.6" x 55.1")	1645 x 753 x 1400 mm (64.8" x 29.6" x 55.1")	1950 x 753 x 1400 mm (76.8" x 29.6" x 55.1")
Gross Internal Dimensions (W x D x H)		915 x 580 x 660 mm (36.0" x 22.8" x 26.0")	1220 x 580 x 660 mm (48.0" x 22.8" x 26.0")	1525 x 580 x 660 mm (60.0" x 22.8" x 26.0")	1830 x 580 x 660 mm (72.0" x 22.8" x 26.0")
Usable Work Area		0.42 m ² (4.5 ft ²)	0.56 m ² (6.0 ft ²)	0.70 m ² (7.5 ft ²)	0.86 m ² (9.3 ft ²)
Tested Opening	203 mm (8")				
Average Inflow Velocity	0.53 m/s (105 fpm)				
Average Downflow Velocity	0.30 m/s (60 fpm)				
Airflow Volume	Inflow	354 cmh (208 cfm)	473 cmh (280 cfm)	591 cmh (348 cfm)	709 cmh (417 cfm)
	Downflow	553 cmh (325 cfm)	738 cmh (434 cfm)	922 cmh (543 cfm)	1107 cmh (652 cfm)
	Exhaust	354 cmh (208 cfm)	473 cmh (278 cfm)	591 cmh (348 cfm)	709 cmh (417 cfm)
	Required Exhaust with Optional Thimble Exhaust Collar	531 cmh (313 cfm)	710 cmh (418 cfm)	887 cmh (522 cfm)	1064 cmh (626 cfm)
	Static Pressure For Optional Thimble Exhaust Collar	32 Pa / 0.12 in H ₂ O	45 Pa / 0.18 in H ₂ O	57 Pa / 0.23 in H ₂ O	68 Pa / 0.27 in H ₂ O
ULPA Filter Typical Efficiency	>99.999% at 0.1 to 0.3 micron, ULPA as per IEST-RP-CC001.3 USA >99.999% at MPPS, H14 as per EN 1822 EU >99.99% on 0.3 micron size particles by PAO test (filter leakage test according to NSF49)				
Sound Emission per NSF / ANSI 49*	57.5 dBA		58.5 dBA	60.5 dBA	
Fluorescent Lamp Intensity	982 lux (91 foot candles)	1025 lux (95 foot candles)	880 lux (82 foot candles)	1035 lux (96 foot candles)	
Cabinet Construction	Main body	1.2 mm (0.05") / 18 gauge EG Steel with Isocide™ Oven-Baked Epoxy-Polyester Powder Coating			
	Work Zone	1.5 mm (0.06") / 16 gauge, SS 304, 4B finish			
	Side Walls	1.5 mm (0.06") / 16 gauge, SS 304, 4B finish			
Electrical 220-240 VAC, 50/60 Hz	Cabinet Full Load Amps (FLA)	8.5	8.6	9.5	12
	Heat Load (BTU / Hr)	472	569	613	849
	Nominal Power Consumption (W)	150	181	195	270
Electrical 110-130 VAC, 50/60 Hz	Cabinet Full Load Amps (FLA)	11	11.5	12.5	15
	Heat Load (BTU / Hr)	503	628	698	999
	Nominal Power Consumption (W)	160	200	222	318
Net Weight**	188 Kg (414 lbs)	230 Kg (507 lbs)	288 Kg (634 lbs)	346 Kg (763 lbs)	
Shipping Weight**	216 Kg (476 lbs)	285 Kg (628 lbs)	356 Kg (784 lbs)	428 Kg (944 lbs)	
Shipping Dimensions, Maximum (W x D x H)**	1120 x 820 x 1760 mm (44.0" x 32.3" x 69.3")	1450 x 820 x 1760 mm (57.0" x 32.3" x 69.3")	1720 x 820 x 1760 mm (68.0" x 32.3" x 69.3")	2050 x 820 x 1760 mm (57.0" x 32.3" x 69.3")	
Shipping Volume, Maximum**	1.62 m ³ (57 ft ³)	2.09 m ³ (74 ft ³)	2.48 m ³ (87 ft ³)	2.96 m ³ (105 ft ³)	

Specifications are subject to change without notice.

*Noise reading in open field condition / anechoic chamber. Noise reading in normal room varies by room size, layout, and background noise, but may reach roughly 3-4 dBA above these values.

**Cabinet only, excludes optional stand.

AC2 Cabinets Save Money and Environment



Description	AC2-4S9 with DC ECM blower	AC2-4S8 with DC ECM blower	Typical BSC with AC Blower	Savings		Units
				AC2-4S9	AC2-4S8	
Instantaneous Power	200	160	800	600	640	Watt
Hours of Operation in a year	2000					Hours
Energy	400	320	1600	1200	1280	kWh
Energy cost in USA at \$ 0.10 / kWh	40	32	160	120	128	USD
Energy cost in EU at € 0.20 / kWh	80	64	320	240	256	Euro
CO ₂ released in USA at 1 lbs / kWh	400	320	1600	1200	1280	lbs
CO ₂ emission in EU at 0.35 Kg / kWh	140	112	560	420	448	Kg

Accessories for AC2-NS Biological Safety Cabinets

Cabinet	Standard Unit	AC2-3S8-NS 2010946	AC2-4S8-NS 2010747	AC2-5S8-NS 2010978	AC2-6S8-NS 2010963
			AC2-3S9-NS 2010945	AC2-4S9-NS 2010752	AC2-5S9-NS 2010977
Unit with Cable Port		AC2-3S8-NS-PORT 2011010	AC2-4S8-NS-PORT 2011011	AC2-5S8-NS-PORT 2011012	AC2-6S8-NS-PORT 2011013
		AC2-3S9-NS-PORT 2011014	AC2-4S9-NS-PORT 2011015	AC2-5S9-NS-PORT 2011016	AC2-6S9-NS-PORT 2011017
Exhaust Ducting	Anti-blowback Valve 10 inches	ABBV-10P 5170352			
	Tri-safe Exhaust Collar with Alarm	TEM-4 2010606			
	Thimble Exhaust Collar with Alarm	ECO-A-AC23 5170618	ECO-A-AC24 5170619	ECO-A-AC25 5170620	ECO-A-AC26 5170621
	Exhaust Damper	B2-DAMPER 5170352			



ABBV-10P



TEM-4



ECO-A-AC2_



B2-DAMPER

Hydrogen Peroxide Decontamination Kit	VHP In Port (Ø 1")	VHP-IN PORT 5170552			
	VHP Out Top Box for Cabinet WITH Exhaust Collar Installed (Ø 1")	VHP-ECO/OUT 5170554	VHP-ECO/OUT 5170615	VHP-ECO/OUT 5170616	VHP-ECO/OUT 5170617
	VHP Out Top Box for Cabinet WITHOUT Exhaust Collar Installed (Ø 1")	VHP OUT TOP BOX 3ft 5170553	VHP OUT TOP BOX 4ft 5170612	VHP OUT TOP BOX 5ft 5170613	VHP OUT TOP BOX 6ft 5170614
Work Zone	UV Lamp	UV-15A 5170251	UV-30A-L 5170255		
	IV Bar	IV-910 5170499	IV-1215 5170231	IV-1520 5170500	IV-1825 5170501
	Pre-filter	PF-41 5090061	PF-42 5090062	PF-43 5090063	PF-44 5090064
Electrical Outlet	Direct Mounted / GFCI	EO_			
Service Fixtures	EU SF-Gas-20 mm	SF-1G20 5170410			
	EU SF-Vacuum-20 mm	SF-1V20 5170457			
	EU SF-Air-20 mm	SF-1A20 5170502			
	EU SF-Nitrogen-20 mm	SF-1N20 5170503			
	EU SF-Water-20 mm	SF-1W20 5170458			
	EU SF-Universal-22 mm	SF-2U22 5170504			
Support Stands, Ships Flat	Fixed Stand with Leveling Feet, 28" height	SAL-3A0 Gen 2 5130170	SAL-4A0 Gen 2 5130134	SAL-5A0 Gen 2 5130171	SAL-6A0 Gen 2 5130172
	Fixed Stand with Leveling Feet, 34" height	SAL-3B0 Gen 2 5130174	SAL-4B0 Gen 2 5130175	SAL-5B0 Gen 2 5130176	SAL-6B0 Gen 2 5130177
	Fixed Stand with Caster Wheels, 28" height	SPC-3A0 Gen 2 5130155	SPC-4A0 Gen 2 5130152	SPC-5A0 Gen 2 5130162	SPC-6A0 Gen 2 5130154
	Fixed Stand with Caster Wheels, 34" height	SPC-3B0 Gen 2 5130165	SPC-4B0 Gen 2 5130166	SPC-5B0 Gen 2 5130167	SPC-6B0 Gen 2 5130168
	Telescopic Stand with Leveling Feet, 1" adjustment	STL-3A0 5130050	STL-4A0 5130051	STL-5A0 5130052	STL-6A0 5130053
	Telescopic Stand with Caster Wheels, 1" adjustment	STC-3A0 5130055	STC-4A0 5130056	STC-5A0 5130057	STC-6A0 5130058
	Motorized height Stand with Caster Wheels, 39.5" height	SPM-3A2 5130093	SPM-4A2 5130047	SPM-5A2 5130100	SPM-6A2 5131141
Misc	IQ/OQ Protocol	9010179			



ESCO LIFESCIENCES GROUP

42 LOCATIONS IN 21 COUNTRIES ALL OVER THE WORLD



- Global Offices
- Licensee
- Distributors
- Factories
- R&D Centers
- Regional Distribution Centers

Follow us on social media, download our apps,
and scan the QR code for more info.



@EscoLifesciences



@EscoLifesciences



@EscoLifesci



@Esc



@EscoLifesciences



@EscoLifesciences



Esc



Esc

ESCO

LIFESCIENCES GROUP

Esco Micro Pte. Ltd. • 21 Changi South Street 1 • Singapore 486 777

Tel: +65 6542 0833 • mail@escolifesciences.com

www.escolifesciences.com

Esco Technologies, Inc. • 903 Sheehy Drive, Suite F, Horsham, PA 19044, USA

Tel: +1 215-441-9661 • Fax 484-698-7757

eti.admin@escolifesciences.com

Esco Lifesciences Group Offices: Bangladesh | China | Denmark | Germany | Hong Kong | India | Indonesia | Italy | Japan | Lithuania | Malaysia | Myanmar | Philippines | Russia | Singapore | South Africa | South Korea | Taiwan | Thailand | UAE | UK | USA | Vietnam